

MAGNET LATCHING VALVES



Series 20 >> Model 26

3-Way Multi-Purpose Magnet Latching Valve

This type of valve is often used in remote areas where continuous power may not be available or with battery-powered portable equipment where power capacity is limited. It is also valuable in equipment where coil heating, due to continuous application of power, is undesirable. Air and other fluids compatible with standard Buna seals. Hot water, steam, gasoline, oils, some hydraulic fluids, and many other media require special seal materials.

- Meets today's demand for economy of space.
- Uses power only during latching and un-latching.
- Great for medical and chemical analyzers.

OPERATING CONDITIONS

Media: Air, water, and other fluids compatible with standard Buna seals. Hot water, steam, gasoline, and many oils require special seal materials. (Series 20 pressure ratings may change due to the viscosity of the liquid.)*

Valve Temperature Range: Standard Valves - 0°F (-18°C) to 104°F (40°C) ambient; 0°F (-18°C) to 150°F (65°C) media. Optional Valves - can tolerate much higher or much lower ambient and media temperatures.

Maximum Operating Pressure Differentials: See table on proceeding page.

Burst Pressure: 5000 PSI

Leakage: Bubble tight for standard valves.

Vacuum: To 5 Microns*

ELECTRICAL CHARACTERISTICS

Coil Voltage: 6 to 60V DC

Nominal Power: DC – 10.0 Watts

Coil Construction: Molded Class B with DIN 43650 Form A Connector (Std.), Leadwires (Opt.) For your convenience we have the female DIN style mating connector No. 20-198** available for an additional fee.*

Typical Response Time on Air: Approximate 30 millisecond pulse to energize and de-energize.

Operating Speed: Up to 600 CPM

MECHANICAL CHARACTERISTICS

Body: Stainless Steel (Std.) or Brass (Opt.)

Internal Components: Stainless Steel

Elastomers: Nitrile (Buna) (Std.). Many other elastomers available.*

Orifice Diameter: See table on proceeding page.

Porting: Standard 1/8" and 1/4" NPT (other ports available).*

Housing: Leadwires and DIN Style Connector.

Listings: Most valves are UL and CSA listed.*

Life Expectancy: Millions of cycles, depending on application, lubrication, etc.

Valve Weight: 1.2 lb average

Repair Packs: See table on proceeding page.

Options: Alternate Port Locations, Metering and Alternate Elastomers.*

* Consult representative or factory for options and specifications.

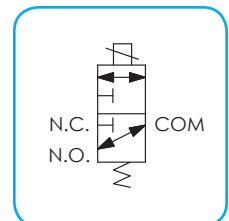
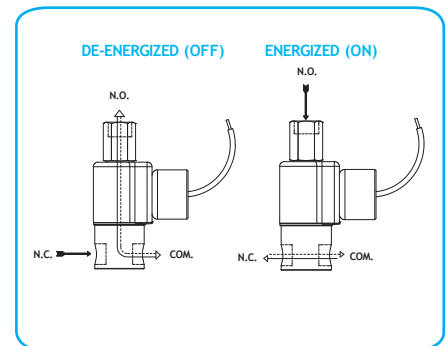

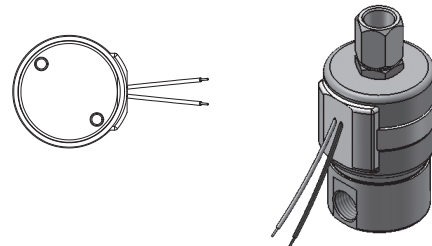
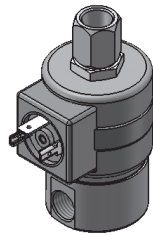
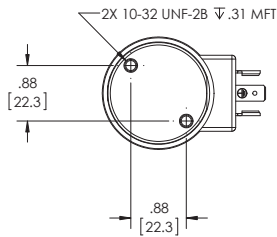
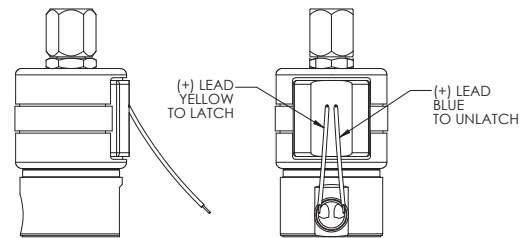
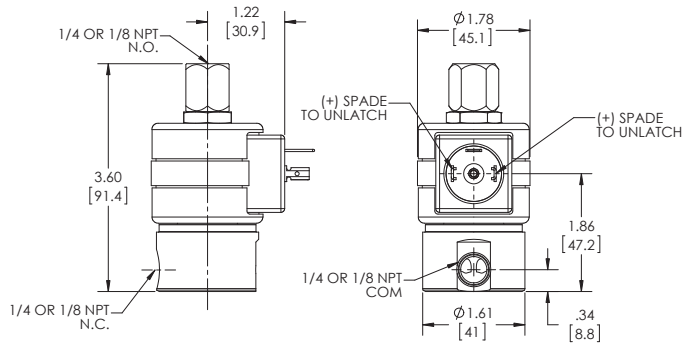

**SERIES 20 MODEL 26
3-WAY MULTI-PURPOSE
MAGNETIC LATCHING DIN COIL**

**SERIES 20 MODEL 26
3-WAY MULTI-PURPOSE
MAGNETIC LATCHING COIL WITH LEADS**

VALVE SPECIFICATIONS

MAX. OPER. PRESS. DIFF.	ORIFICE SIZE		CV FACTOR		DIN COIL		VALVE NUMBER		GROMMET HOUSING	
	DC	N.C.	N.O.	N.C.	N.O.	1/8 NPT PORTS	1/4 NPT PORTS	1/8 NPT PORTS	1/4 NPT PORTS	
400	1/32	1/32	.024	.024	26GG7XELM	26GG9ZELM	26GG7XGLM	26GG9ZGLM		
150	3/64	3/64	.052	.052	26HH7XELM	26HH9ZELM	26HH7XGLM	26HH9ZGLM		
100	1/16	1/16	.095	.095	26JJ7XELM	26JJ9ZELM	26JJ7XGLM	26JJ9ZGLM		
75	3/32	3/32	.156	.156	26KK7XELM	26KK9ZELM	26KK7XGLM	26KK9ZGLM		

WHEN ORDERING VALVES OR REPAIR PACKS ADD VOLTAGE AND FREQUENCY TO COMPLETE VALVE NUMBER. EXAMPLES: VALVE (26JJ7XELM-12/DC) REPAIR PACK (K26JJXL-DC).